



The Old Volks Home

Volkswagen Hazard Switch Wiring

Over the years, I have received inquiries regarding the proper wiring of the Hazard (Emergency) Light Switch installed on various VW models. The purpose of this PDF is to consolidate the answers to those inquiries and provide proper wiring instructions so that you can have Hazard Lights that actually work. This PDF is divided by VW model, beginning with Standard Beetle, Super Beetle (71-72), Karmann Ghia, Type 2, Type 3 and Type 4.

Beetle Late 68-69

From Vin 1x8 381 367, using 111-953-235 D, 211-953-235 A Switch

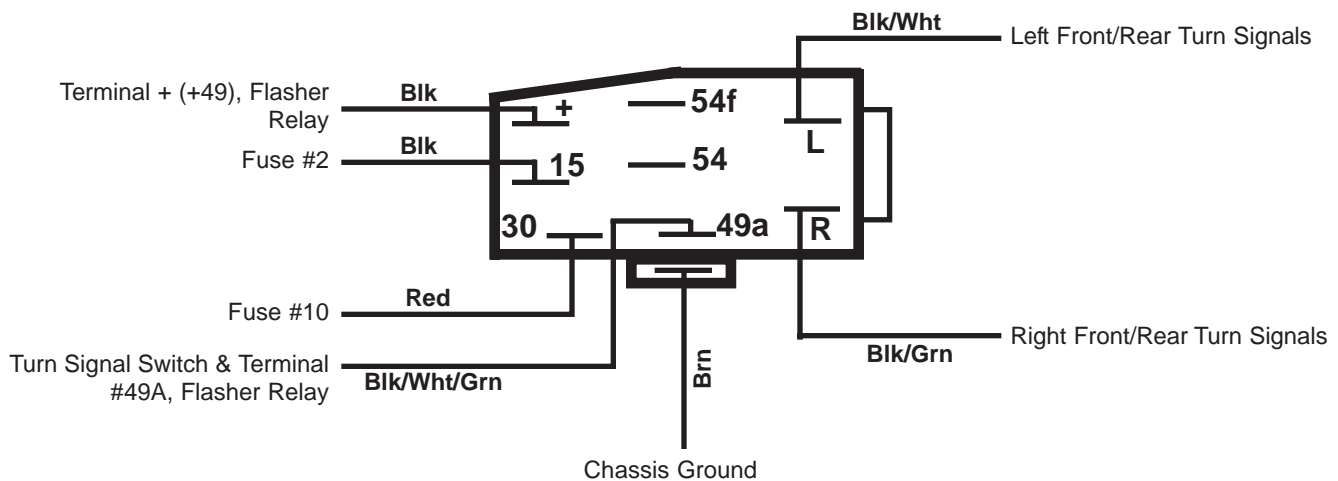

Note: This terminal is not present on original switch. Add a Brown Wire when using replacement switch or if this terminal is present.



The Old Volks Home

Volkswagen Hazard Switch Wiring

Standard Beetle 70-71

With 10 Pole Fuse Box using 211-953-235 A Switch

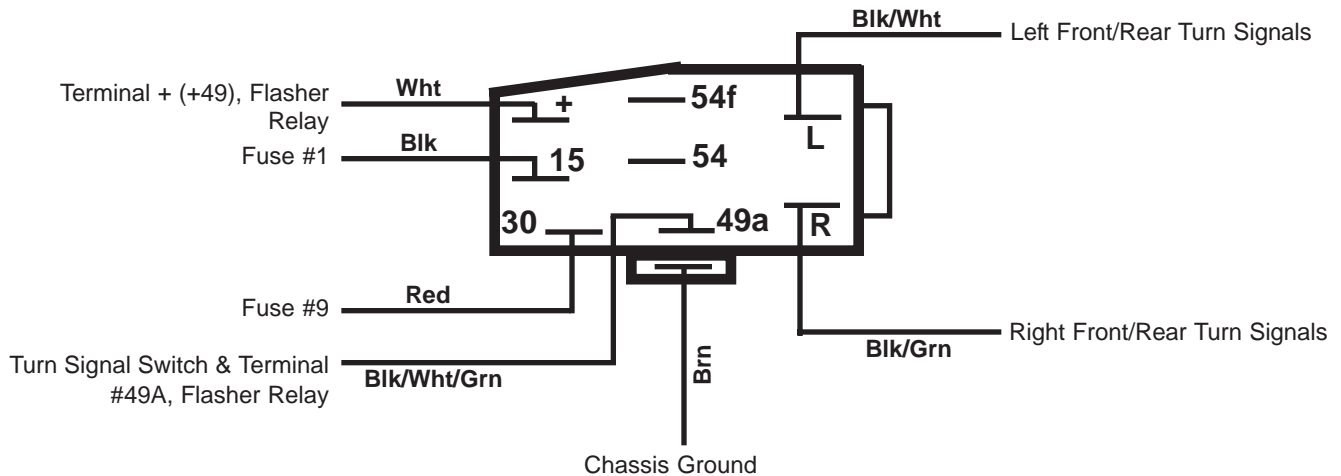

Note: This wire is also connected to Terminal 31 on the Brake Warning Light and Terminal 31 on the Wiper Switch and then to Chassis Ground

Standard Beetle Late 71 & 72-73

With 12 Pole Fuse Box using 211-953-235 A Switch

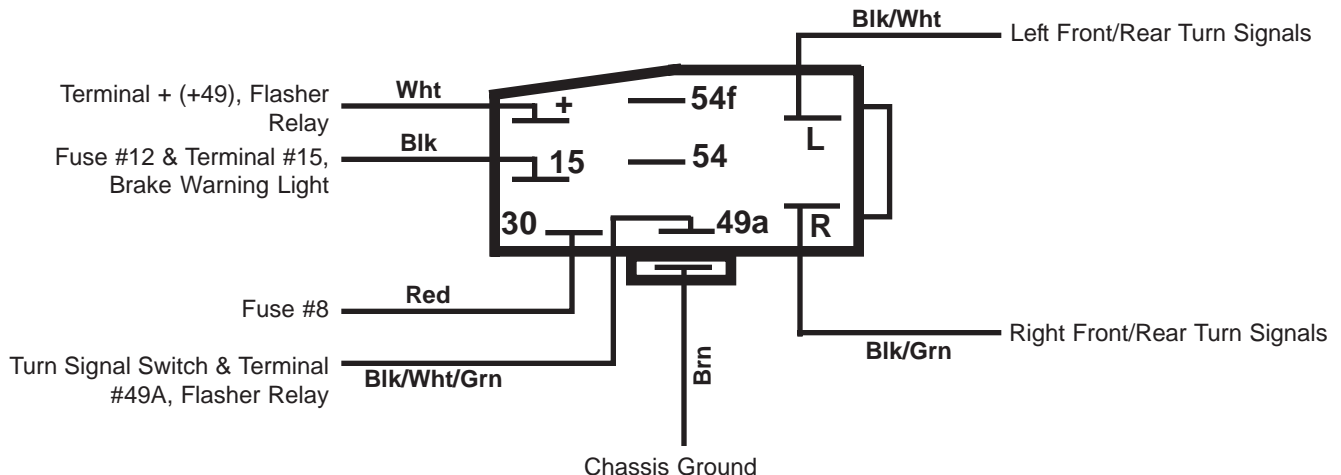

Note: This wire is also connected to Terminal 31 on the Brake Warning Light



The Old Volks Home

Volkswagen Hazard Switch Wiring

Standard Beetle 74-77

With 12 Pole Fuse Box using 111-953-235 G Switch

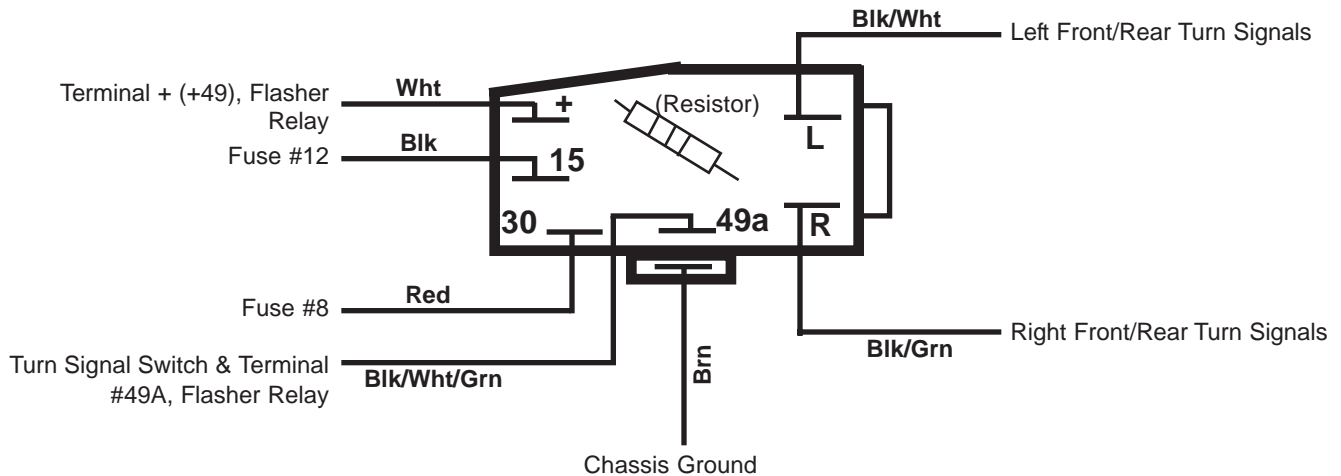

Super Beetle 71-72

With 12 Pole Fuse Box using 211-953-235 A Switch

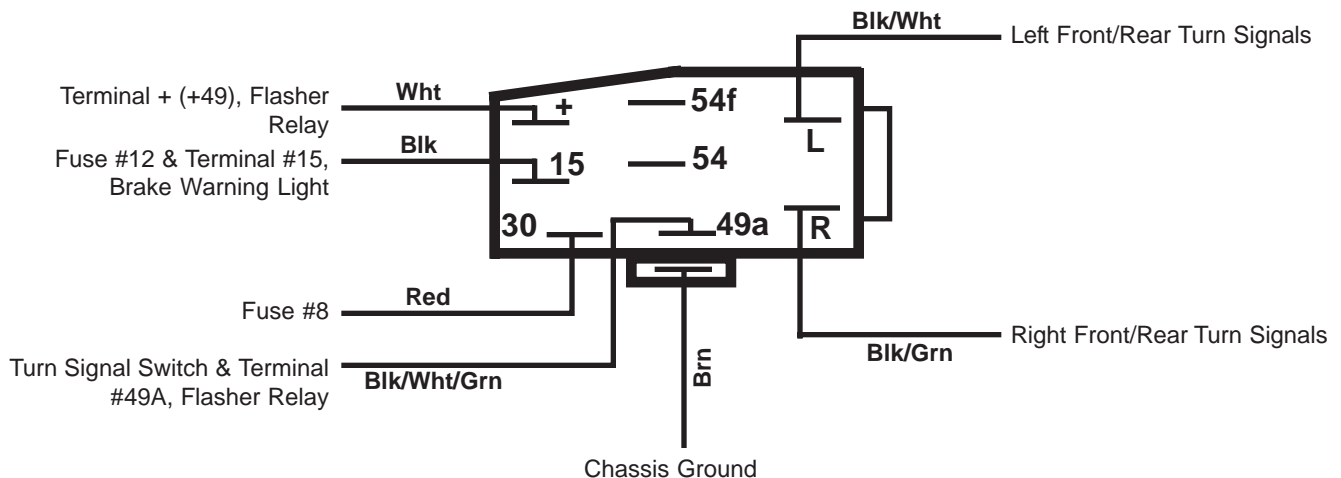

Note: This wire is also connected to Terminal 31 on the Brake Warning Light



The Old Volks Home

Volkswagen Hazard Switch Wiring

Karmann Ghia Late 68-69

From Vin 148 433 379, using 111-953-235 D, 211-953-235 A Switch

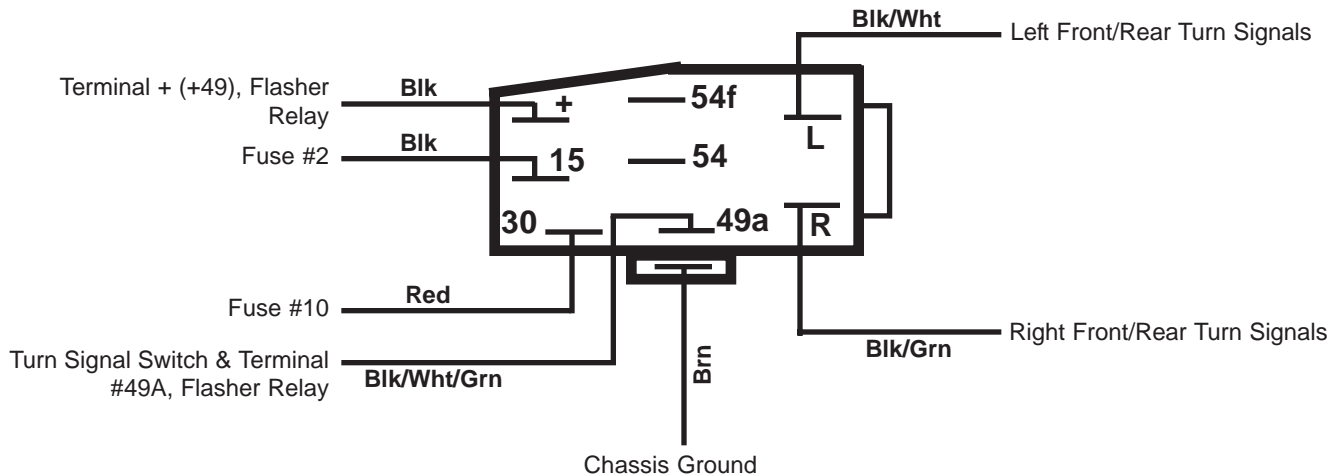

Note: This terminal is not present on original switch. Add a Brown Wire when using replacement switch or if this terminal is present.

Karmann Ghia 70-71

With 10 Pole Fuse Box using 211-953-235 A Switch

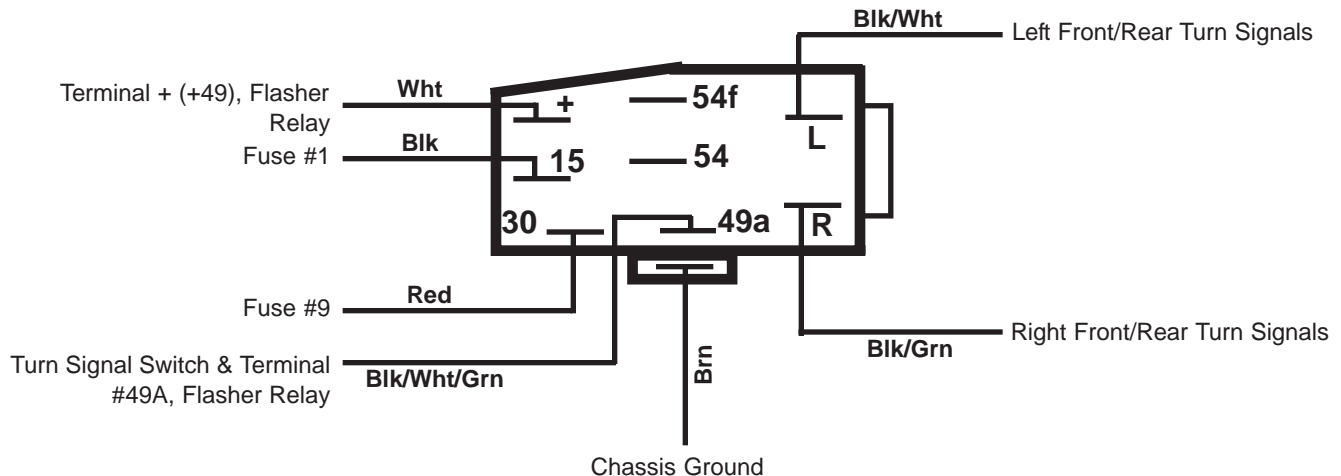

Note: This wire is connected to Terminal 31 on the Brake Warning Light, the Ground Connections on the Speedometer Pod, Fuel Gauge, Clock, Terminal 31 on the Wiper Switch, Terminal 31 on Flasher Relay and then to Chassis Ground



The Old Volks Home

Volkswagen Hazard Switch Wiring

Karmann Ghia 72-74

With 12 Pole Fuse Box using 211-953-235 A Switch

Note: Some 72-74 K Ghias used 111-953-235 G Switches.

If your Ghia has this switch, refer to the Standard Beetle 74-77 Diagram

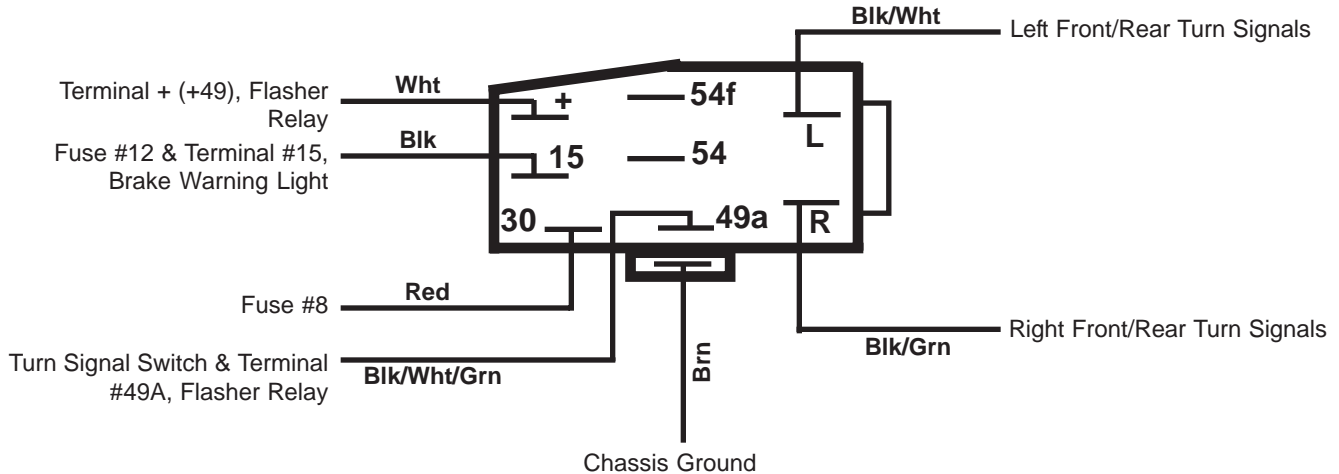

Note: This wire is connected to Terminal V & 31 on the Brake Warning Light, the Ground Connections on the Speedometer Pod, Clock Pod, Terminal 31 on the Wiper Switch, Terminal 31 on Flasher Relay and then to Chassis Ground

Type 2 Late 68-69

From Vin 2x8 098 286, using 111-953-235 D, 211-953-235 A Switch

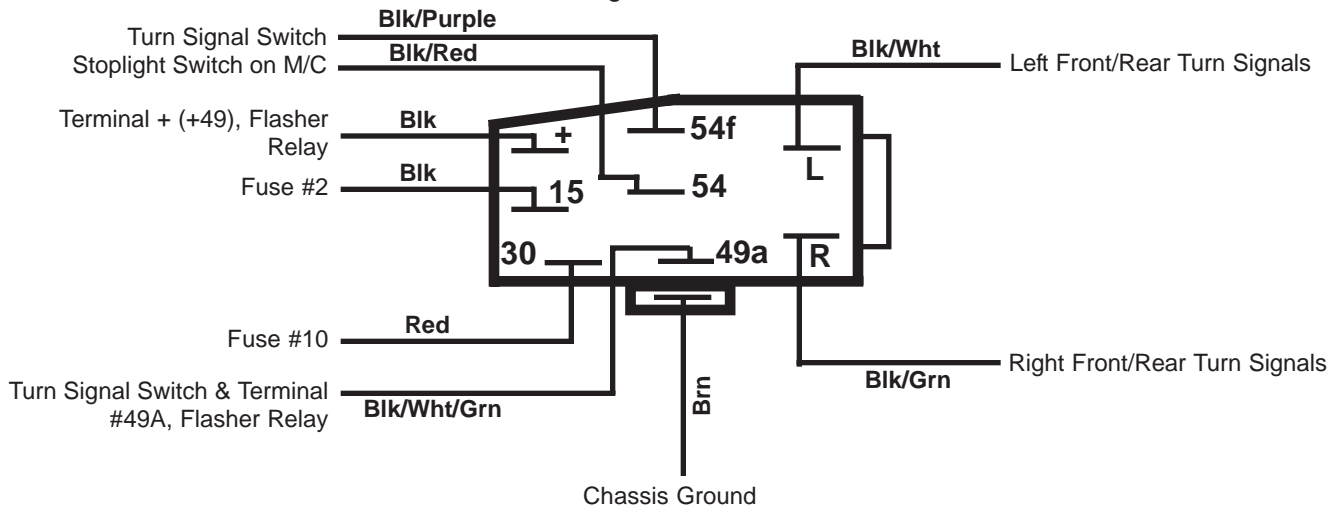

Note: This terminal is not present on original switch. Add a Brown Wire when using replacement switch or if this terminal is present.



The Old Volks Home

Volkswagen Hazard Switch Wiring

Type 2 70-71

Using 211-953-235 A Switch

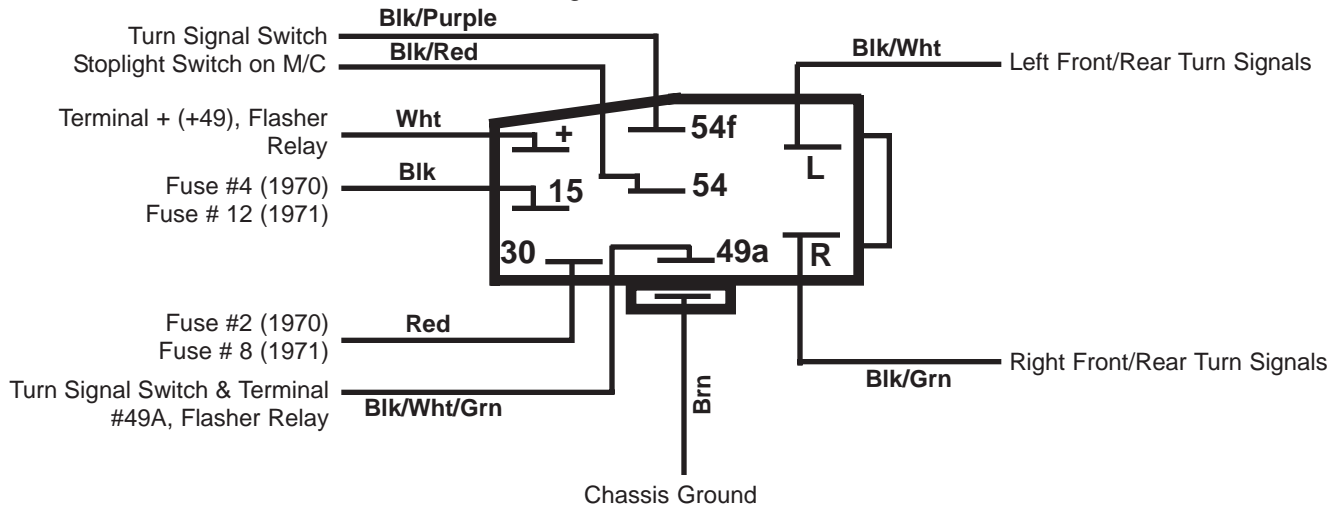

Type 2 1972

Using 211-953-235 A Switch

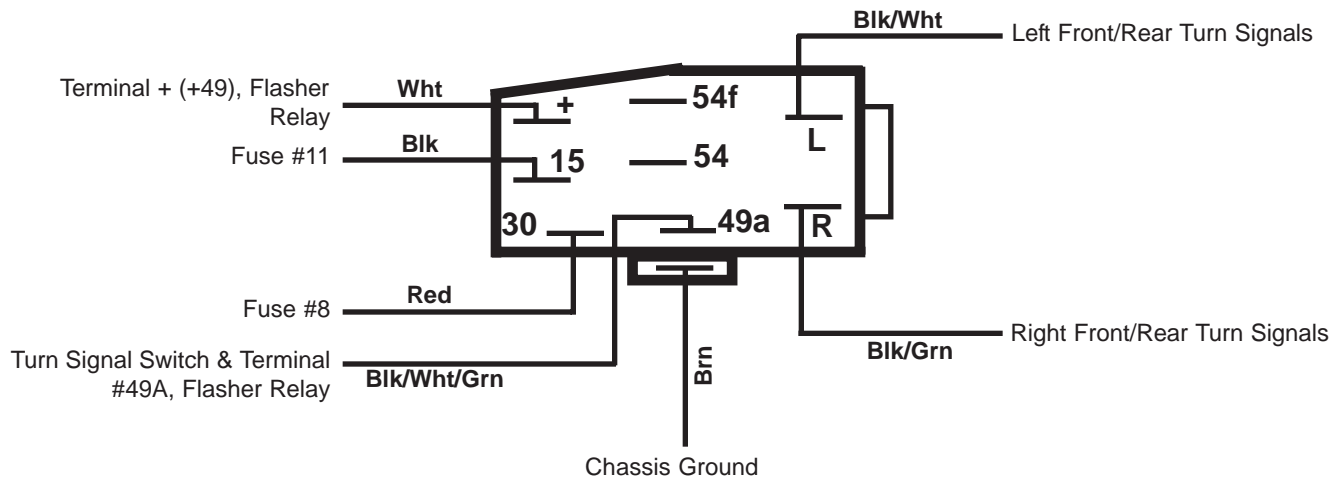



The Old Volks Home Volkswagen Hazard Switch Wiring

Type 2 73-79

Using 111-953-235 G Switch

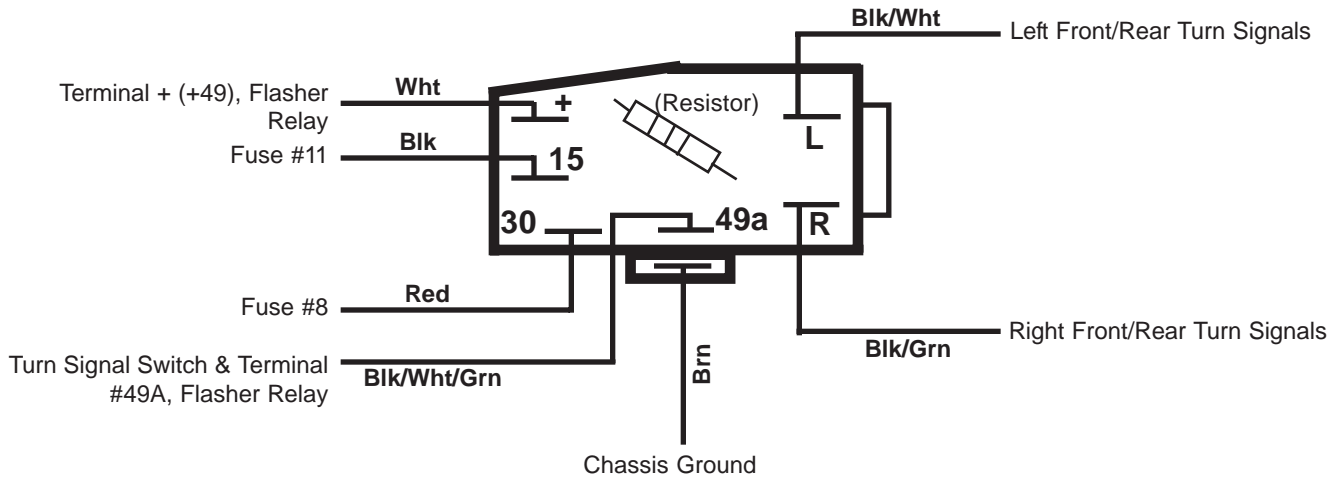

Type 3 Late 68-69

From Vin 3x8 103 326, using 111-953-235 D, 211-953-235 A Switch

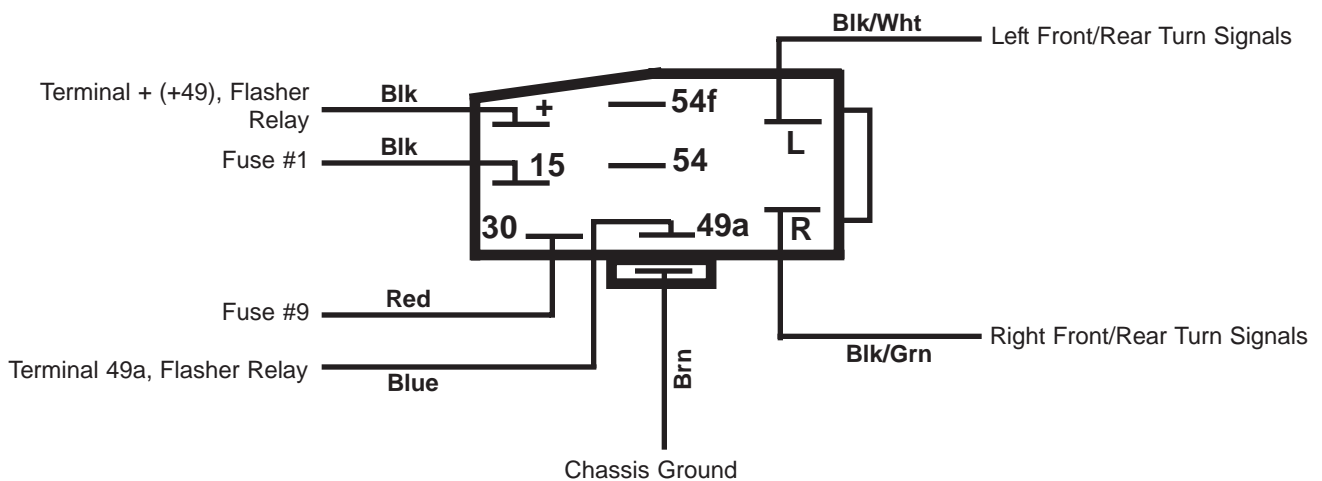

Note: This terminal is not present on original switch. Add a Brown Wire when using replacement switch or if this terminal is present.



The Old Volks Home

Volkswagen Hazard Switch Wiring

Type 3 70-71

Using 211-953-235 A Switch

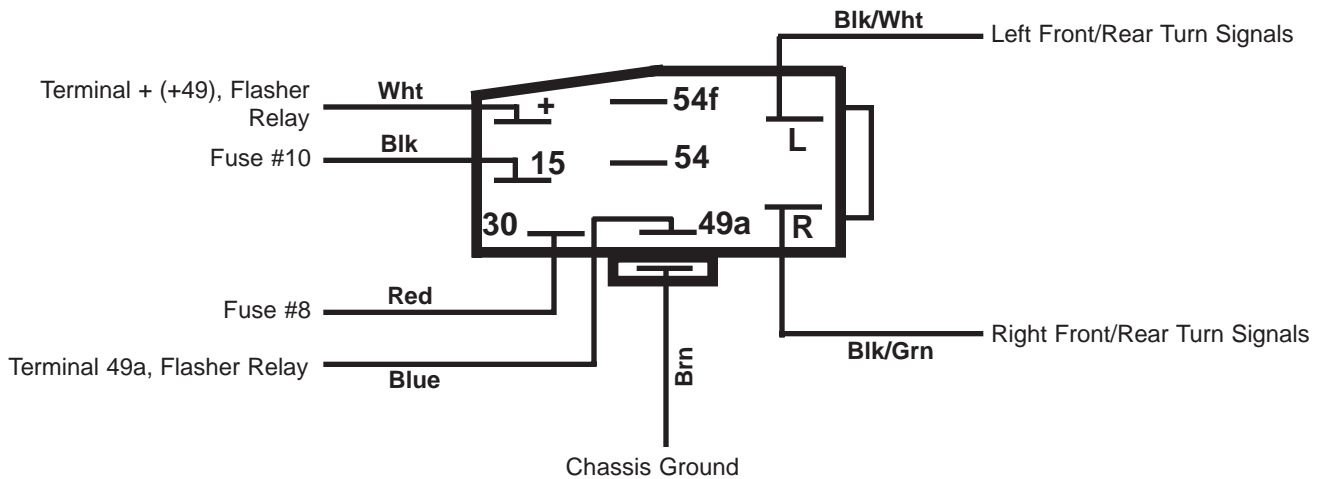

Type 3 1972

Using 211-953-235 A Switch

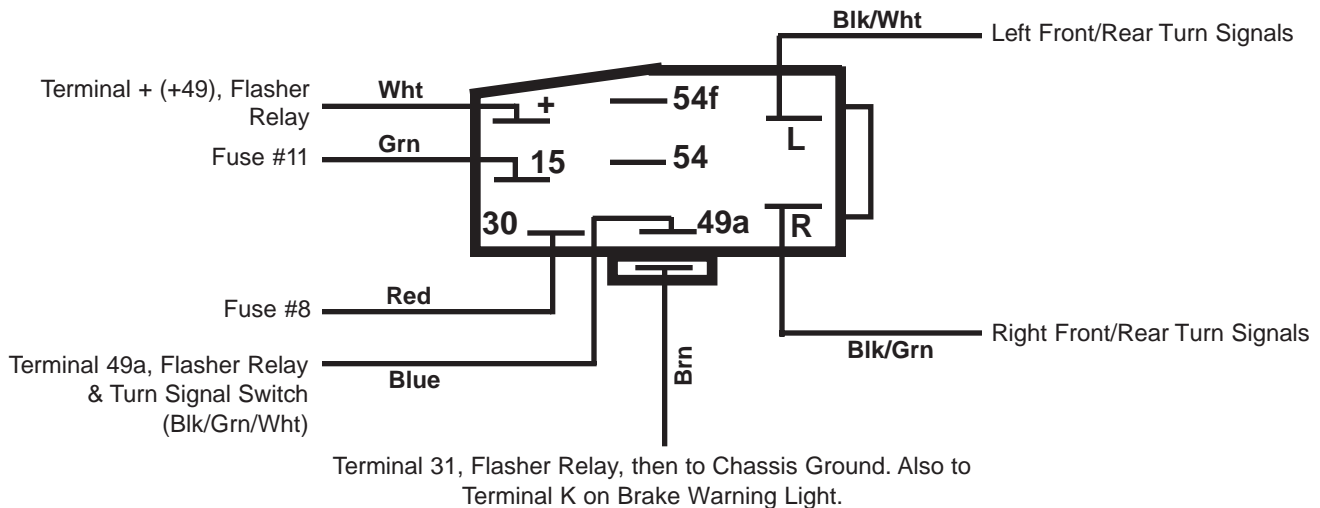

Contents of this PDF are Copyright (c) 2007 James Thompson & The Old Volks Home and may not be reproduced or used without the expressed permission of James Thompson and The Old Volks Home. The Old Volks Home Logo is a trademark of The Old Volks Home and may not be reproduced or used without the expressed permission of The Old Volks Home. Volkswagen is a registered trademark in the United States and other countries. The Old Volks Home is not affiliated with, nor connected in any fashion with Volkswagen Of America, Volkswagenwerk AG, Germany, nor any of its established affiliates, dealers or subsidiaries. The use of "Volkswagen", the VW Logo and its models in this PDF is for purely descriptive purposes and the items listed herein are not Genuine Volkswagen products unless otherwise noted.



The Old Volks Home

Volkswagen Hazard Switch Wiring

Type 3 1973

Using 111-953-235 G Switch

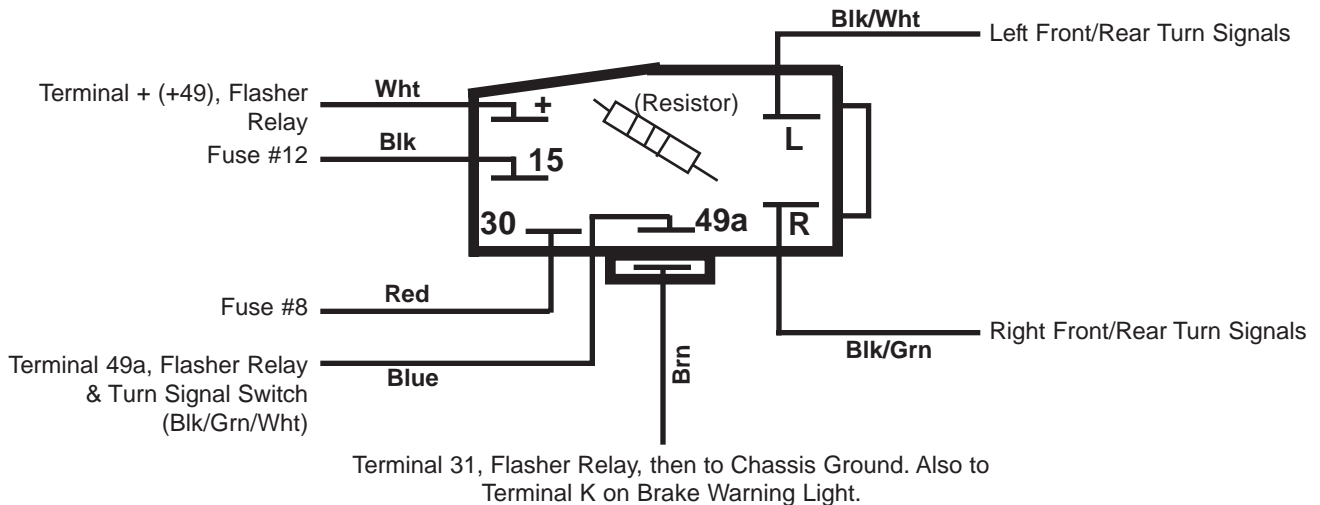

Type 4 71-74

Using 411-953-235 B Switch

